

# Assemble instruction

G×2

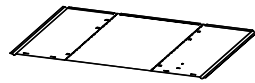

# List of carcass parts

A×1



H×2

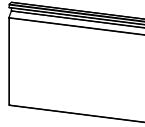

B×1

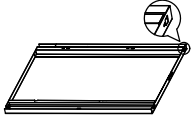

I×2

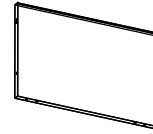

C×1

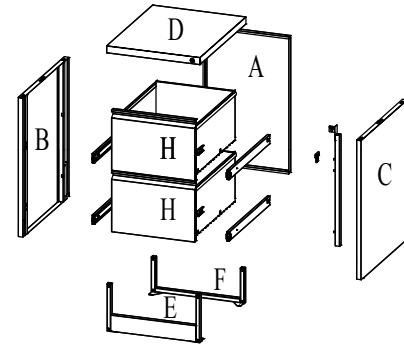
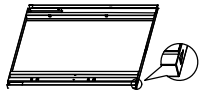

D×1

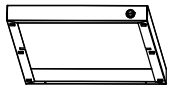

ST4.2×8 6PCS ST4.8×12 4PCS ST2.9×8 2PCS Plastic clip 2PCS

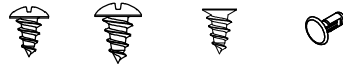

# Finish

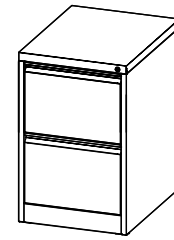

E×1

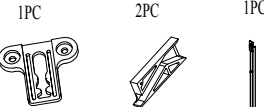

F×1



Step 1

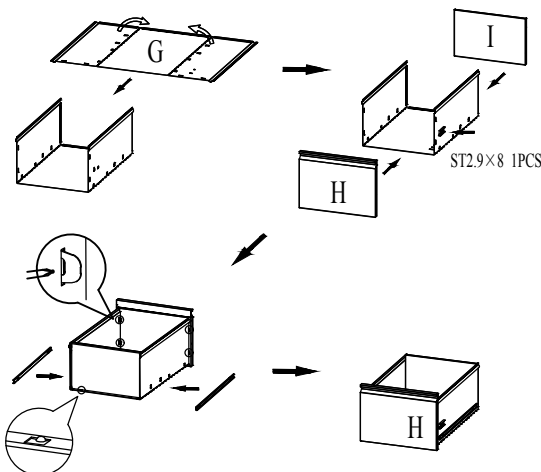

Step 2

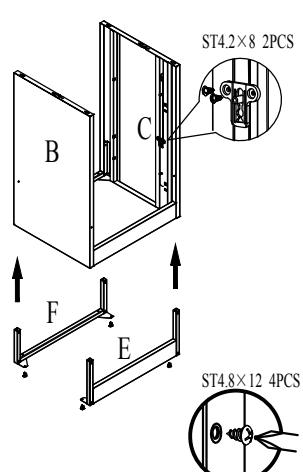

Step 3

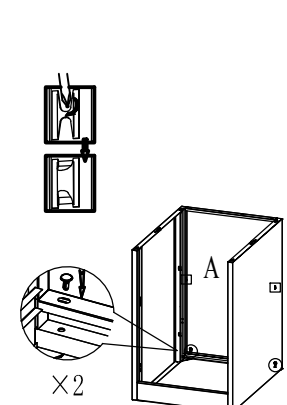

Step 4

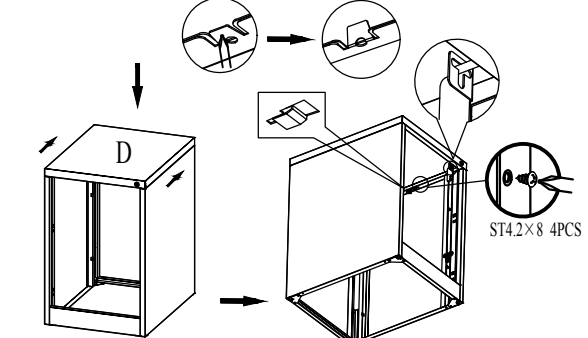

Step 5

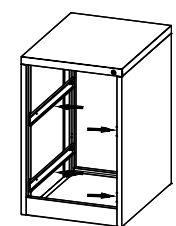

Step 6

