

Assemble instruction

G×1



List of carcass parts

A×1



H×3



B×1

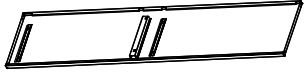

I×2

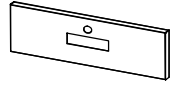

C×1



J×2

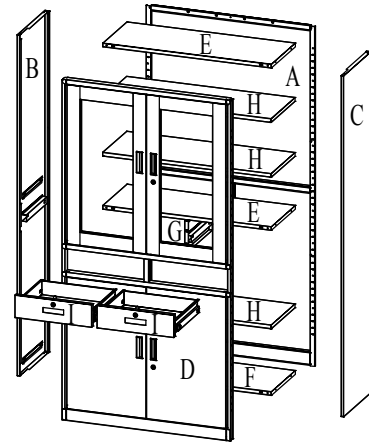
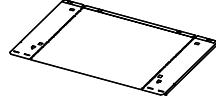

D×1



K×2

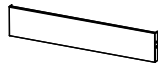

Finish

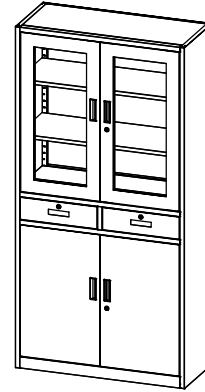

E×2



M4×8 9PCS

12PCS



F×1

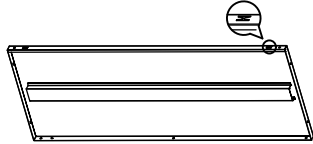

4 Pair

4PCS



Step 1

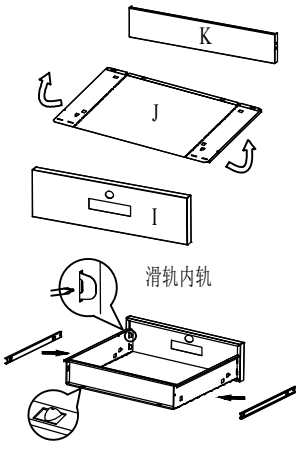

Step 2

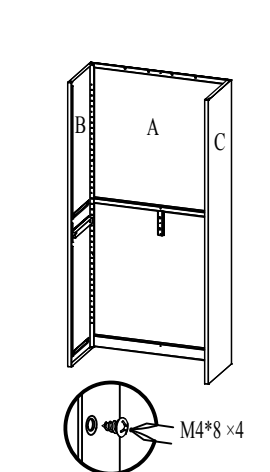

Step 3

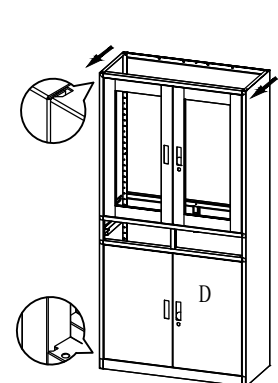

Step 4

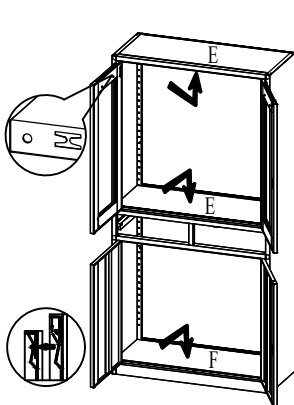

Step 5

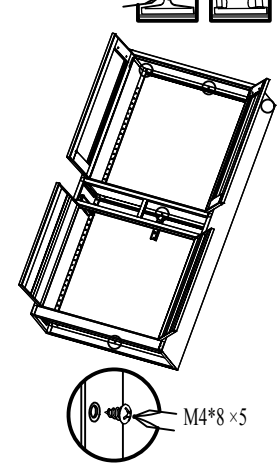

Step 6

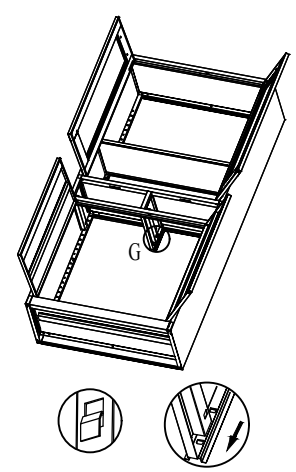

Step 7

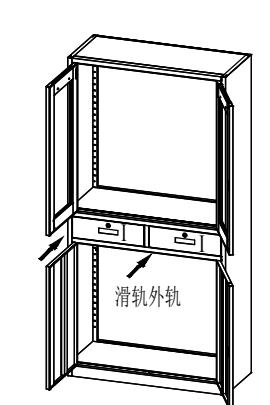

Step 8

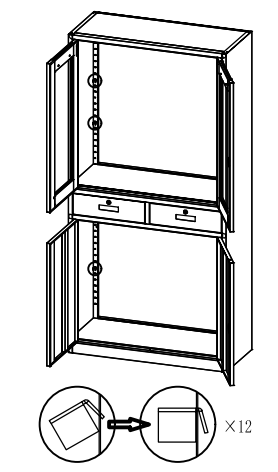

Step 9

